

MegaPX WDR MiniDome Z2



The **MegaPX WDR MiniDome Z2** from March Networks® is an economical, fixed indoor IP camera with a remote zoom/focus lens for easy set-up. It combines high-definition (HD) video resolution with powerful Wide Dynamic Range (WDR), for excellent image quality in all lighting conditions. It is an ideal alternative to similarly-priced analog cameras, offering all the advantages of IP video, and is a perfect complement to the March Networks 8000 Series Hybrid NVR platform.



NO COMPROMISE IP VIDEO MIGRATION

For cost-conscious organizations ready to start migrating to the IP camera world, the MegaPX WDR MiniDome Z2 delivers IP video capabilities and an upgrade to HD video from standard-definition analog video at an exceptional price.

SYSTEM INTEGRATION

The MegaPX WDR MiniDome Z2 integrates seamlessly with March Networks Command™ video management software and high-performance hybrid NVRs to provide convenient browser-based management. The camera is also ONVIF S-compliant, allowing it to be used with a wide range of third-party systems.

VIDEO STREAMING

The camera's support for H.264 compression technology results in up to 20 times the efficiency of comparable JPEG-based IP cameras. This enables the archiving of higher-quality video for longer periods of time, while significantly reducing bandwidth and storage costs. The MegaPX WDR MiniDome Z2 can stream at

30 fps at maximum resolution, and record video independently to an optional SD High Capacity (microSDHC) card. In addition, the camera can accommodate dual H.264 and M-JPEG streams simultaneously in real time to address different live or recording applications.

CAMERA RECORDING

The camera's ability to stream in parallel to an internal microSDHC card ensures redundant recording in the event of a network outage or server failure. When used with our Command software and hybrid NVRs¹, the solution's Shadow Archiving feature provides seamless access to redundant video for total fail-safe management. It does this by forming a "shadow" on the central recording server of all the data available on the camera's microSDHC card

ECONOMICAL AND FLEXIBLE

Power over Ethernet (PoE) simplifies the installation of the camera by eliminating the need for additional cables for power. The camera is quick and easy to install, and the pan/tilt position of its lens can be manually adjusted to deliver an even more flexible application.

FEATURES

- 1080p or 720p image
- Best-in-class WDR
- True Day/Night
- Alarm and audio I/O
- Active video tampering
- Privacy masks
- Progressive scan CMOS sensor
- Remote zoom/focus, 3-10.5mm, DC iris lens
- Vandal resistant
- Shadow Archiving with microSDHC
- ONVIF S-compliant for open integration with third-party systems
- Simultaneous H.264 and M-JPEG compression streams
- Surface mount
- Easy to install
- Power over Ethernet
- March Networks Cloud support

PART NUMBERS

CAMERA

- 31571 - 2MP
- 31571-SD - 1MP

ACCESSORIES

- 28319 – Indoor Flush Mount Adaptor
- 30327 – 1.5" NPT Mount Adaptor
- HOMINIDOMESMA – Pendant Mount
- HOMINIDOMEWB – Wall Mount
- HOMINIDOMEPPMA – Pole Adaptor
- 28317 – Indoor Electrical Plate Adaptor (Surface)
- 30323 – Side Cable Access Housing
- 27639 – Corner Adaptor
- 27392 – Tinted Bubble (10 Pack)

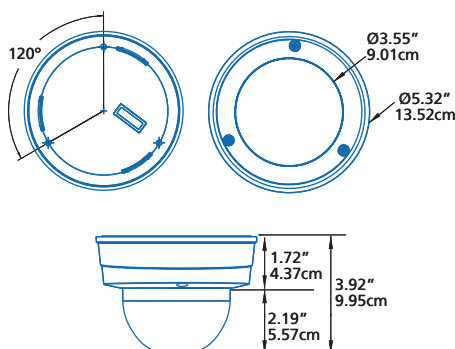

MegaPX WDR MiniDome Z2

CAMERA

Image Sensor	1/2.7" CMOS progressive scan
Lens	3-10.5mm, F1.2, DC iris, remote zoom/focus, Angle of view: 30°–100°(horizontal)
Minimum Illumination	Color: 0.6 lux @ F1.2 (30IRE, AGC on) B/W: 0.01 lux @ F1.2 (30IRE, AGC on)
Wide Dynamic Range	100dB
Shutter Time	1/25 to 1/10000 sec
Camera Angle Adjustment	Pan 360°, Tilt 156°, Rotation 360°

VIDEO

Video Compression	H.264, M-JPEG
Resolution: 31571	1080p (1920x1080) to CIF (352x288)
31571-SD	720p (1280 x 720) to CIF (352x288)
Frame Rate: 31571	Up to 30 fps @ 1080p
31571-SD	Up to 30 fps @ 720p
Video Streaming	Dual-stream H.264 and M-JPEG (1080p or 720p on stream 1; D1 on stream 2) Controllable frame rate and bandwidth CBR/VBR H.264; VBR M-JPEG (quality settings)
Image Settings	Wide dynamic range, anti-flicker, white balance mode, brightness, contrast, saturation, hue, sharpness, mirror mode, privacy masks, motion detection

AUDIO

Audio streaming	two way
Audio Compression	G.711 PCM, G.726 ADPCM, configurable bit rate
Audio Input/Output	Stereo line in, stereo line out

NETWORK

Security	Password protection, IP address filtering, connection management, LDAP authentication, HTTPS encryption (configuration only)
Supported Protocols	ONVIF S, RTP, RTSP, RTCP, HTTP, HTTPS, IPv4, TCP,UDP,DHCP,ARP,LDAP,802.1X









SYSTEM INTEGRATION

Intelligent Video	Video motion detection, active tampering
Alarm Triggers	Video motion detection, active tampering, external input
Alarm Events	Video recording to local storage (microSDHC); external output activation

GENERAL

Housing	Light-weight, durable vandal-resistant, indoor plastic housing
Power	Power over Ethernet IEEE 802.3af Class 0
Connectors	Female RJ-45 100BASE-TX PoE, 1 alarm input, 1 alarm output, audio line in, audio line out
Local Storage	microSDHC memory card (not included)
Operating Conditions	14 to 122°F / -10 to 50°C, 0–90% relative humidity non-condensing
Regulatory Approvals	CE – EMC Directive; 2004/108/EC; Standards EN55022; EN55024; FCC Part 15 Subpart B; ICES-003; UL-60950-1; ROHS2 (2011/65/EU); C-Tick; EN61000-3-2; WEEE
Mechanical	
Weight	1.1 lb / 0.5 kg
Dimensions (HxD)	3.92 x 5.32 in. / 9.95 x 13.52 cm
Included Accessories	Software CD (including Installation Guide and User Manual, March Networks SiteManager, and Browser), mounting template

MOUNTING OPTIONS

	Part Number		Part Number
	28319 Indoor Flush Mount Adaptor		HOMINIDOMEPMA Pole Adaptor Also requires 30327 1.5" NPT Mount Adaptor and HOMINIDOMEWB Wall Mount
	30327 1.5" NPT Mount Adaptor		28317 Indoor Electrical Plate Adaptor (Surface)
	HOMINIDOMESMA 1.5" NPT Pendant Mount Also requires 30327 1.5" NPT Mount Adaptor		30323 Side Cable Access Housing
	HOMINIDOMEWB 1.5" NPT Wall Mount Also requires 30327 1.5" NPT Mount Adaptor		27639 Corner Adaptor

NOTES: ¹ In order to take advantage of Shadow Archiving, this feature must also be supported on the recorder.

North America 1 800 563 5564
Latin America +5255 5259 9511
Europe +39 0362 17935
Asia +65 6818 0963
Australia and New Zealand +61 1300 089 419
Middle East and Africa +971 4 399 5525

© 2016, March Networks, An Infinova Company. All rights reserved. Information in this document is subject to change without notice. MARCH NETWORKS, March Networks Command, March Networks Searchlight, March Networks RideSafe, Shadow Archive and the MARCH NETWORKS logo are trademarks of March Networks Corporation. Infinova is a trademark of Infinova Corporation. All other trademarks are the property of their respective owners. 060-3160-01-H **marchnetworks.com**

An Infinova Company